

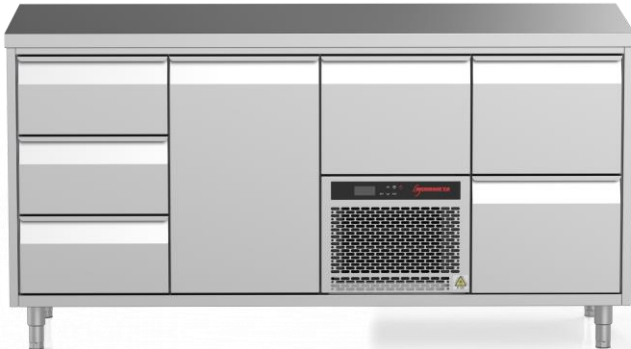

# COOLING/FREEZING COUNTERS AND SALADETTE COUNTERS

FP0-E\*\*\*, FPS-E\*\*\*, FPR-E\*\*\*, FM0-E\*\*\*, FS0-E\*\*\*

## Installation, Operation and Maintenance Manual



VALID FROM 2024 SEPTEMBER

## Introduction

One of the key issues in catering sector is handling food. And refrigerating plays the lead role. *Novameta* can offer efficient appliances for storing, serving, and also displaying food in temperatures, lower than surroundings. The materials used are selected for attractive appearance, optimum performance and maximum durability. Every unit is inspected and tested before shipping.

This manual guide explains how to install, use and maintain the purchased product properly to reach optimal performance.

## Recommendations

Upon receipt, inspect units immediately for any shipping damage and notify carrier immediately if damage is found. It must be reported immediately (upon delivery) in writing in the CMR. Otherwise neither the Manufacturer nor the carrier can take responsibility for transport damage. All items are thoroughly inspected and carefully packed before leaving our factory, thus Novameta cannot accept responsibility for any shipping damage, however Novameta will assist in filing a claim.

# Contents

1.	General information.....	4
1.1.	Key.....	4
1.2.	Specifications .....	6
1.3.	GN container application for drawers .....	9
1.4.	Instruction for use .....	9
1.5.	Receiving equipment.....	9
2.	Safety regulations.....	10
2.1.	Operating .....	10
2.2.	Service.....	11
3.	Installation.....	13
3.1.	General requirements.....	13
3.2.	Location .....	13
3.3.	Electrical connection.....	14
3.4.	Defrosting water .....	14
3.5.	Cooling counters connected to the central refrigeration system .....	15
4.	Operation .....	15
4.1.	User interface.....	15
4.2.	Basic operations .....	16
4.3.	Electric height adjustable cooling counters .....	16
4.4.	Display icons .....	17
4.5.	Indication, alarm and error codes .....	17
4.6.	Maximum and minimum temperature alarms .....	18
5.	Maintenance and cleaning .....	18
6.	Disposal .....	19

## 1. General information

### 1.1. Key

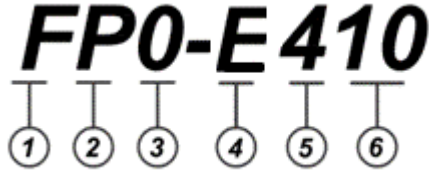

- ① **F - cooling equipment**
- ② **Type of tabletop:**
  - O* no tabletop
  - P* standard flat tabletop
  - M* granite tabletop
  - S* Saladette countertop
- ③ **Additional features:**
  - O* no additional features
  - R* electric height adjustable
  - S* neutral drawer
- ④ **Working temperature:**
  - E* -5 ... +8°C (R290)
  - 20 ... -18°C (R290)
  - +2 ... +8°C (central cooling)
- ⑤ **Number of sections**
- ⑥ **Number of door/drawer configuration (see table below)**

	1½ sections	2½ sections	3½ sections	4½ sections
With doors	F**E101	F**E202	F**E303	F**E404
For baking trays 400 x 600 mm	F**E105	F**E206	F**E307	-
With large drawers	F**E111	F**E212	F**E313	F**E414
For beer boxes 420 x 360 x 250 mm	F**E115	F**E216	F**E317	-
With small drawers	F**E121	F**E222	F**E323	F**E424
Low	F**E125	F**EP226	F**E327	F**E428
Low with a neutral drawer	F**S-E125	F**S-E226	F**S-E327	-
With doors and large drawers	-	F**E230 F**E231	F**E332 F**E335	F**E433
				F**E434
				F**E436
				F**E437
				F**E438
				F**E439
				F**E454
				F**E456
With doors and small drawers	-	F**E240 F**E241	F**E342 F**E345	F**E443
				F**E444
				F**E445
				F**E447
				F**E448
				F**E449
Atypical	-	F**E253 F**E259	F**E351 F**E357 F**E358	F**E452
				F**E455

## 1.2. Specifications

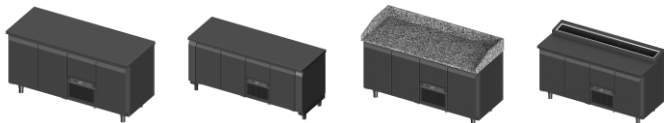

 **Ensure saladette (FS0-E\*\*\*) wells are full with GN containers at all times, even if they are unused or empty. Empty wells will greatly reduce efficiency of the appliance.**

### Cooling Counters

Model							F**-E1**	F**-E2**	F**-E3**	F**-E4**	F**-N1**	F**-N2**
Monoblock	Operating temperature	Power, W	Imput, A	Voltage/frequency	Refrigeration agent	Amount of refrigeration	Energy consumption					
K-ESMP-N5-T8-1-4	-5 ... +8	148	0,64	230-240/50	R290	100	1,14 kWh/24h, A	1,24 kWh/24h, A	1,33 kWh/24h, A	1,69 kWh/24h, B	-	-
K-ESMP-N18-N20-1-2	-20 ... -18	542	4,1			90	-	-	-	-	6,61 kWh/24h, F	7,20 kWh/24h, E
Dimensions, LxWxH, mm							940x700x900	1300x700x900	1720x700x900	2130x700x900	940x700x900	1300x700x900
Transportation weight, kg							70	100	130	160	70	100
Exterior/interior							Stainless steel					
Volume, l							E101 - 123 E111 - 93 E121 -100	E202 - 215 E212 - 155 E222 - 169 E230 E231 - 185 E240 E241 - 192 E253 E259 - 162	E303 - 307 E313 - 217 E323 - 238 E332 - 277 E335 - 247 E342 - 284 E345 - 261 E351 - 254 E357 E358 - 261	E404 - 399 E414 - 279 E424 - 307 E433 E434 - 369 E436 E437 - 339 E438 E439 - 309 E443 E444 - 376 E446 E447 - 353 E448 E449 - 330 E452 - 300 E454 - 339 E455 - 293 E456 - 339	N101 - 123 N111 - 93 N121 - 100	N202 - 215 N212 - 155 N222 - 169 N230 N231 - 185 N240 N241 - 192 N253 N259 - 162
Insulation							Housing: polyurethane: 53 mm; Tabletop: polyurethane, 55 mm; Doors/drawers: polyurethane, 50 mm					
Controls							Digital					
Type of refrigeration							Ventilated					
Defrosting							Automatic					
Climate class							5; + 40°C and 40 % humidity			3; + 25°C and 60 % humidity		
Noise Level							<65 dB					

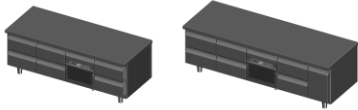

### Low cooling counter / Low cooling counter with neutral drawer

Monoblock						Model	F**-E1**	F**-E2**	F**-E3**	F**-E4**	F**-E1**	F**-E2**
Operating temperature	Power, W	Input, A	Voltage/frequency	Refrigeration agent	Amount of refrigeration, g	Energy consumption						
K-ESMP-N5-T8-1-4	-5 ... +8	148	0,64	230-240/50	R290	100	1,03 kWh/24h, A	1,12 kWh/24h, A	1,2 kWh/24h, A	1,52 kWh/24h, B	-	-
K-ESMP-N18-N20-1-2	-20 ... -18	542	4,1		90	-	-	-	-	3,87 kWh/24h, D	4,61 kWh/24h, D	
Dimensions, LxWxH, mm						940x700x900	1300x700x900	1720x700x900	2130x700x900	940x700x900	1300x700x900	
Transportation weight, kg						70	100	130	160	70	100	
Exterior/interior						Stainless steel						
Volume, l						E125 - 46	E226 - 92	E327 - 138	E428 - 215	N125 - 46	N226 - 92	
Insulation						Housing: polyurethane: 53 mm; Tabletop: polyurethane, 55 mm; Doors/drawers: polyurethane, 50 mm						
Controls						Digital						
Type of refrigeration						Ventilated						
Defrosting						Automatic						
Climate class						5; + 40°C ir 40 % humidity			3; + 25°C ir 60 % humidity			
Noise Level						<65 dB						

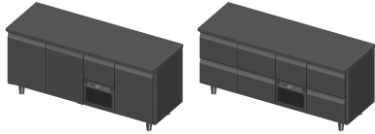

### Cooling counter for beer boxes / Cooling counter for baking trays

Monoblock						Model	F**-D105 F**-D115	F**-D206 F**-D216	F*0-D307 F*0-D317
	Operating temperature	Power, W	Input, A	Volt-age/fre- quency	Refrigeration agent	Amount of refrigera- tion, g	Energy consumption		
K-ESMP-N5-T8-1-4	-5 ... +8	148	0.64	230-240/50	R290	100	1,18 kWh/24h, A	1,3 kWh/24h, A	1,4 kWh/24h, A
Dimensions, LxWxH, mm							1010x700x900	1460x700x900	1960x700x900
Transportation weight, kg							90	110	130
Exterior/interior							Stainless steel		
Insulation							Housing: polyurethane: 53 mm; Tabletop: polyurethane, 55 mm; Doors/draw- ers: polyurethane, 50 mm		
Volume, l							D105 - 166 D115 - 119	D206 - 301 D216 - 207	D307 - 463 D317 - 295
Controls							Digital		
Type of refrigeration							Ventilated		
Defrosting							Automatic		
Climate class							5; +40°C and 40 % humidity		
Noise Level							<65 dB		



### 1.3. GN container application for drawers

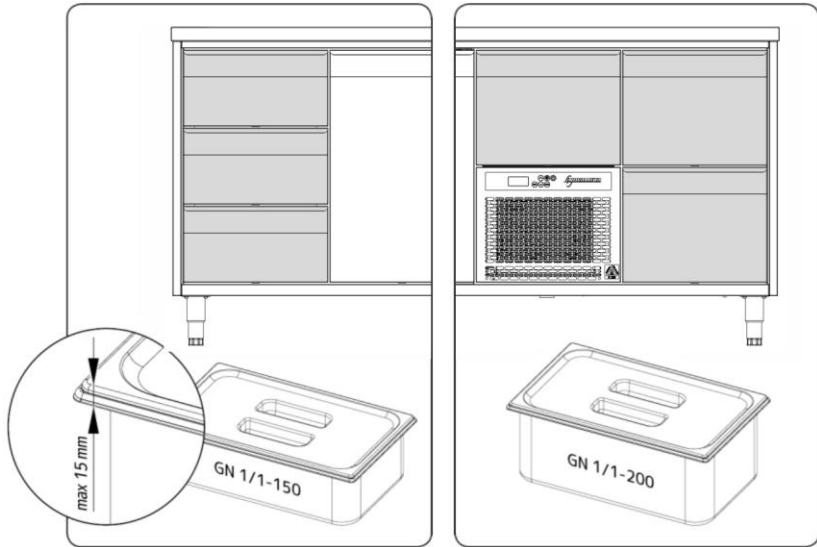

### 1.4. Instruction for use

To ensure that you get optimum use of your purchased product, please read these instructions carefully before putting it to use. Save these instructions for future reference.

**Cooling counters and saladette counters are designed for short term chilled food storage (cooling counters and saladette counters with working temperature: +2 ... +8 °C and -5 ... +8 °C) and for short term frozen food storage (only cooling counters with working temperature: -20 ... -18 °C).**

### 1.5. Receiving equipment

Check the packaging and cabinet for shipping damage before and after unloading the unit, and after removing all the packaging.

The receiver of this product is responsible for filing freight damage claims. This equipment must be opened immediately for inspection. All visible damage must be reported to the freight company and must be noted on freight bill at the time of delivery.

## 2. Safety regulations



### 2.1. Operating

These units are intended for indoor use only. This unit is not intended for use by persons with reduced physical, sensory, or mental capabilities except the case, when they are instructed about safe operating before. Ensure proper supervision of children and keep them away from unit. Make sure all operators are instructed on safe and proper use of unit. Do not operate unattended.

Monitor temperatures closely for safety. *Novameta* is not responsible for actual food product serving temperature. It is the responsibility of the user to ensure that food product is held and served at a safe temperature.



**ELECTRIC SHOCK, FIRE OR BURN INJURIES CAN OCCUR IF THIS EQUIPMENT IS NOT USED PROPERLY. TO REDUCE RISK OF INJURY:**

-  **Flammable refrigeration agent, do not use open flames near the unit. Repairs must only be carried out by suitably qualified personnel in a well-ventilated room;**
-  **Do not use electrical devices inside the cabinet;**
- Have the unit installed by qualified service personnel;**
- Plug only into grounded electrical outlets matching the required voltage;**
- Unit should be used in a flat, level position;**
- Unplug the unit before cleaning or moving.**
- During normal operation, parts in the refrigeration system might reach high temperatures;**
- Touching these components might cause burns or injuries;**
- Do not damage the refrigeration system parts.**
- Do not use mechanical devices or other means to accelerate the defrosting process, except for those recommended by the manufacturer;**
- Do not damage the cooling system pipeline.**

To ensure correct and efficient air flow in the counter, there must be an air gap free of products left (see fig. 1) for best air circulation between the sides, bottom and top.

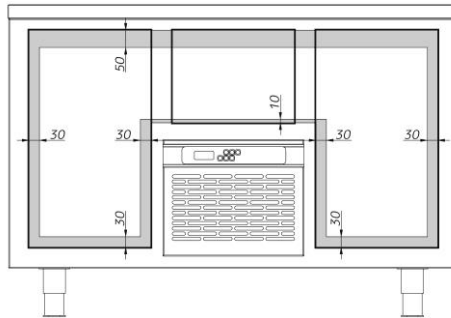



Fig. 1. Air gap left for circulation

All the unwrapped and unpacked products must be covered to avoid corrosion of the interior parts of the counter. Foods containing acetic acid or yeast should be wrapped up in plastic film. Otherwise they may accelerate corrosion of evaporator and metal parts, resulting failure.

Bottles stored near the air outlet may freeze up and break, causing a risk of injury. Moist and fresh foods with strong smell should be wrapped up in plastic film or packed container. Otherwise the food may dry up or give their smell to other foods.



 **If any controller parameters are changed from default, this could cause that the appliance is not functioning normally. Harmful temperatures could damage products, kept inside the unit.**

If the appliance is turned off, wait minimum for 4 minutes before turning the appliance again. This must be done in order to protect compressor from damage.

 **Tabletop cannot be in contact with stuff/surface hotter than 60°C (hot cookware, equipment, etc.)**

## 2.2. Service

To avoid serious injury or damage, never attempt to repair this equipment or replace a damaged power cord yourself. Contact a qualified professional repair service.

  **Always disconnect the product before servicing or replacing any electrical component.**

If operating fails first look to see whether the unit has been unfortunately switched off, or whether the fuse has blown. If failure cannot be found, contact your supplier quoting Model and Serial No. of the product. This information is on the nameplate of the unit.

The refrigeration system and the hermetically sealed compressor require no maintenance. However the condenser and air filter requires regular cleaning.

The compressor compartment the condenser must be kept free from dust and dirt. This is best done with a vacuum cleaner and a brush.

A malfunctioning refrigeration monoblock can easily be replaced with a new one:

1. Disconnect the unit from the power supply;
2. Open the drawer above the compressor door (Fig. 2);
3. Pull the lower part of the door towards you with a screwdriver (Fig. 3);
4. Lift the door upwards (Figure 4);
5. Unhook the door (Fig. 5);
6. Disconnect the power cable, the control panel connector and the earth cable (Figure 6);
7. Pull out the refrigeration monoblock (Figure 7);
8. Replace the old monobloc with the new one by sliding it into the body of the freezing table;
9. Connect the power cable, the control panel connector and the earth cable;
10. Attach the door;
11. Slide the door down and hold the bottom of the door against the housing by sliding it forwards;
12. Connect the unit to a power source and switch it on.

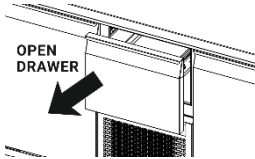

2 Fig.

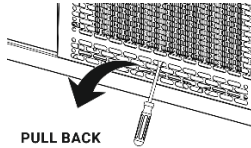

3 Fig.

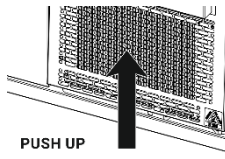

4 Fig.

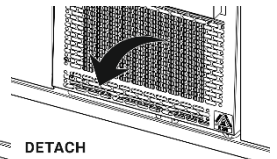

5 Fig.

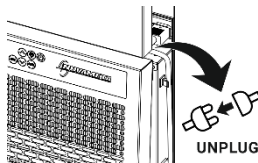

6 Fig.

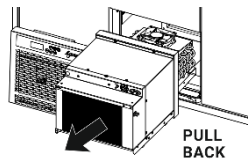

7 Fig.

QR to video on how to remove the compressor door and replace the monoblock:

VIDEO:



## 3. Installation

### 3.1. General requirements

This unit must be installed by qualified, trained installers. Installation must conform to all local electrical codes. Check with local electrical inspectors.

After the transportation, the counter must stand upright at least 2 hours before it is started to allow the liquids of the system to run back. Before starting to operate the equipment, protective film must be taken off from all the surfaces of the counter and the unit must be cleaned internally with a mild soap solution and checked thoroughly before it is put into operation.

If the additional tabletop (Wood, Granite) is applied F0\*-P\*\*\* cooling counter, use adhesive for metal, wood and granite. We recommend that the adhesive is resistant to moisture and chemicals.



**IMPORTANT!**

**In places where warning triangles and/or screws are used to secure covers around electrical parts, there is a risk of severe injury if covers are removed. Therefore, covers must only be removed by a service technician.**

### 3.2. Location

The counter should be located in a dry and adequately ventilated room. To ensure efficient operation, it must not be placed facing draft winds, in direct sunlight or against heat-emitting surfaces.

Set up-place must be level and horizontal. If the counter is fitted with legs, the legs must be adjusted to ensure that it stands level and not distorted in any way. If the unit is fitted with castors, it must stand on a flat floor; the wheels have to be locked when the counter is in place. In time, an uneven floor might distort the appliance to the extent that door and drawer operation becomes difficult.

If the counter is to be fixed on a wall, make sure that it stands level and undistorted.

Avoid placement of the counter in a chlorine/acid-containing environment (swimming-bath etc.) due to risk of corrosion.



**IMPORTANT!**

**Do not block vent holes in the front panel.**

**Do not damage the refrigeration system.**

**Do not use electrical devices inside the cooling/freezing table.**



**The units must have minimum 90 mm air gap between the bottom and any surfaces or objects below and also between the sides of the unit and surrounding planes.**

### 3.3. Electrical connection

All the units are tested by producer to assure proper operation. Power must be connected via a wall socket. The wall socket should be easily accessible.

The unit is intended for connection to alternating current. The connection values for voltage (V) and frequency (Hz) are given on the nameplate. The nameplate shown in the fig. 8 is intended purely as an example.

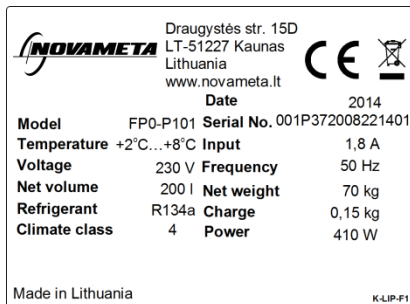

Fig. 8. Example of the nameplate

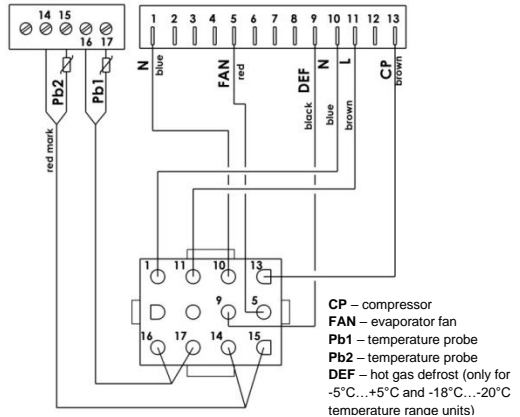

Fig. 9. The wiring diagram



**WARNING!**

**This appliance must be earthed.**

Power must be connected via a wall socket. Only the supplied cord is to be used. The wall socket should be easily accessible. Products must only be connected to such a network (grid), which is protected by circuit breakers.



**Never use an extension cord for this appliance. If a wall socket is placed in a longer distance than the length of the supplied power cord, contact an electrician to install a wall socket within the range of the supplied power cord.**

All earthing requirements stipulated by the local electricity authorities must be observed. The cooling/freezing table plugs and wall socket should then give correct earthing. If in doubt, contact your local supplier or authorized electrician.

### 3.4. Defrosting water

Defrost water is led through a pipe, from the evaporator and into a tray below compressor and condenser. Here, water is evaporated by the heat from hot Freon gas from compressor and hot air from condenser.



**Never use sharp or pointed objects to accelerate the defrosting process.**

### 3.5 Cooling counters connected to the central refrigeration system

Connect the following in advance to the future location of the refrigeration table to be connected to the central refrigeration system:

1. Refrigeration systems piping;
2. Power supply connection;
3. Condensate discharge pipe to sewer system.

Connection of the refrigeration system to the central refrigeration system and launching can be performed only by properly qualified personnel or companies.

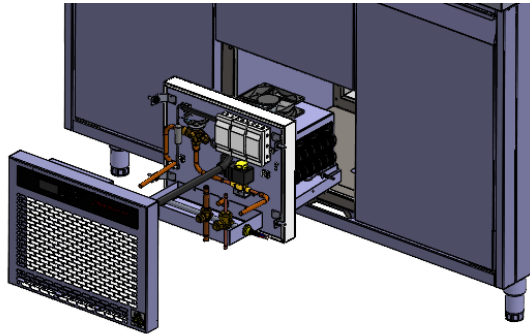

Fig. 10. Central cooling system

## 4. Operation

### 4.1. User interface

The user interface is represented by the front panel, which features: up to 6 keys. A 9 mm, 4-digit display where 3½ digits plus negative/positive sign are used to display as symbols or numbers the resources being studied, plus 14 LED icons to provide a visual indication of states or alarms.



Fig. 11. The display

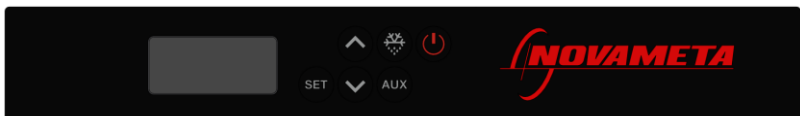









Fig. 12. The keypad

## 4.2. Basic operations

Press and hold the ON/STAND BY (ESC)  for a few seconds. To set up the temperature, press SET  and choose the needed temperature using arrows (2) (to increase the temperature press  and to decrease it press ) , after selection press SET  again. To manually turn defrost on, press and hold the defrost button  for 4 seconds and defrost will start immediately.

## 4.3. Electric height adjustable cooling counters

Height of electric height adjustable cooling counters (models F\*R-\*\*\*\*) can be set using the controller on the upper right corner of the unit (fig. 13).

Press and hold  to increase the height of the unit and , to decrease it.

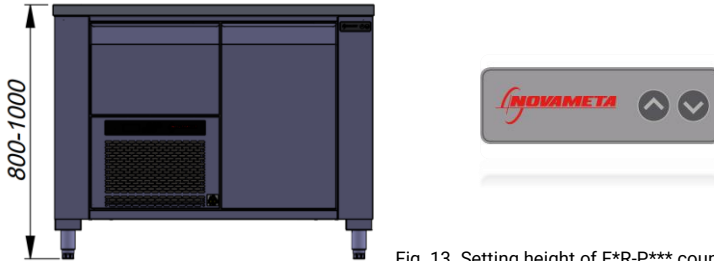







Fig. 13. Setting height of F\*R-P\*\*\* counters



## 4.4. Display icons

The display icons are not configurable; they are associated with one particular system operation event. The associated functions are:

FUNCTION	LED STATE	N.B.
Degrees Celsius °C	<i>On</i> = Indicates that the measurement is in degrees Celsius <i>Off</i> = otherwise	Depends on parameter drO
Degrees Fahrenheit °F	<i>On</i> = Indicates that the measurement is in degrees Fahrenheit <i>Off</i> = otherwise	Depends on parameter drO
Standby 	<i>On</i> = controller off <i>Off</i> = controller on	Device off = Stand-by
Overcooling 	<i>On</i> = Overcooling active <i>Off</i> = Overcooling not active	Overcooling activates manually (see keypad function above) and depends on parameters tOC and OrC
Compressor 	<i>On</i> = compressor on. <i>Blink</i> = modify set point, compression protection with activation blocked. <i>Off</i> = otherwise	A protection may intervene depending on how parameters have been programmed
Defrost/dripping 	<i>On</i> = defrost on <i>Blink</i> = dripping underway <i>Off</i> = otherwise	When Defrost is requested but the compressor is set to defrost protection, the defrost will be postponed
Evaporator fan 	<i>On</i> = fan running. <i>Off</i> = fan off <i>Blink</i> = fan stopped	The Fan Block depends on parameter F3
Alarm 	<i>On</i> = in the event of alarm or error <i>Off</i> = normal function	

## 4.5. Indication, alarm and error codes

CODE	SIGNIFICANCE
rhL	Function in low relative humidity
rhH	Function in high relative humidity
Loc	Keypad locked
UnL	Keypad unlocked
---	Function not available
AL	HACCP low temperature alarm
AH	HACCP high temperature alarm
id	HACCP door switch alarm
Pr1	Cold Room Probe Error
Pr2	Evaporator probe error

## 4.6. Maximum and minimum temperature alarms

PARAMETER	DESCRIPTION	RANGE	DE-FAULT	UM	NOTE
Att	Alarm parameters mode	0/1/2	0	num	0 = absolute, 1 = relative
LAL	Minimum alarm	50.0 ... HAL	-10	°C/°F	
HAL	Maximum alarm	LAL ... 150	10	°C/°F	
Afd	Alarm set differential	0.1 ... 15.0	2	°C/°F	
tAO	Alarm signalling, delay	0 ... 240	10	min	Refers solely to high or low cold room probe temperature alarms.
PAO	Exclude alarm on switching on	0 ... 240	1	ora	Refers solely to high or low cold room probe temperature alarms.

The alarm temperature always refers to the cold room and never to the evaporator. Alarm regulation is based on the cooling table probe. There are two possible types of alarm: maximum and minimum alarm.

The temperature limits defined in parameters HAL and LAL are determined by parameter Att, which specifies if they represent the absolute temperature value or set point differential.

**N.B.: relative alarm values are considered with no sign and subtracted in the event of a minimum alarm and summed for maximum alarms. Alarm delays refer to power on, end of defrost and end of evaporator stop.**

## 5. Maintenance and cleaning



**Always disconnect the equipment before cleaning. Do not flush compressor compartment and evaporator with water as this may cause short-circuits in the electrical system.**

Wipe the interior metal surfaces with a paper towel to remove any remaining food debris. Clean interior with a damp cloth or sponge and any good commercial detergent at the recommended strength.

Clean the stainless steel by using a soft cloth and mild soap solution. If it is not sufficient, try a non-abrasive liquid stainless steel polish.

The equipment should be checked before it is put into operation again. Be sure they are completely rinsed away with clear water, immediately after cleansing. Chemical residue could corrode surface of unit. For the external maintenance, use stainless steel polish.

The compressor compartment must be kept free from dust and dirt. This is best done with a vacuum cleaner and a brush.

To avoid damaging organic glass, do not use cleaners containing alcohol.

### **Cleaning of counter with drawers:**

If the cooling/freezing table is equipped with drawer and the bottom, sides or back wall require cleaning, the drawer can be removed as follows:

Pull out the drawer by lifting it up and pulling the drawer off the extension rails.

After cleaning, the drawer can be replaced. Place the drawer on the outer wheels on the telescopic rails. Lower the drawer into a horizontal position and push it into a closed position.



**Cleansing agents containing chloride or compounds of chlorine as well as other corrosive means, may not be used, as they might cause corrosion to the stainless panels of the unit.**

Do not spray outside of unit or controls with liquid or cleaning product. **Liquid could enter the electrical compartment and cause a short circuit or electric shock.**



**To avoid damaging the finish, do not use abrasive materials, scratching cleaners or scouring pads. Always rub along the grain of stainless steel polish.**



**BEFORE CLEANING ALWAYS BE SURE THE UNIT IS TURNED OFF.**

## 6. Disposal

EU regulations require refrigeration product to be disposed of by specialist companies who remove or recycle any gas, metal and plastic components.

Consult your local waste collection authority regarding disposal of your appliance. Local authorities are not obliged to dispose of commercial refrigeration equipment but may be able to offer advice on how to dispose of the equipment locally.

# Terms and Conditions

## **Applicability**

These terms and conditions (hereinafter referred to as “Terms”) apply to all products supplied directly by Novameta to its distributors, except separate contracts (in writing) exceptions.

## **Validity of Quotations**

Quotations are valid for 30 days unless otherwise explicitly stated in the individual quotation. Not responsible for misprints.

## **Delivery Terms**

Provided in the proforma invoice. Liability for cargo depends on INCOTERMS 2010 specified in the proforma invoice. In case of ex-works Novameta shall not be liable for delays and the distributor shall not be permitted to terminate the purchase due to delays unless agreed to in writing.

## **Payment Terms**

Provided in the proforma invoice. If a higher credit limit is necessary, security is mandatory. Novameta may reduce a credit limit at any time if considered appropriate by Novameta.

## **Storage Terms**

Provided in the proforma invoice.

## **Retention of Title**

Novameta shall retain title in all products and components sold to the distributor until the distributor has paid for the products in full (including transportation and packaging costs).

## **Warranty Terms**

Novameta provides a Manufacturer’s warranty for all the equipment (except cooling counters and backbar cooling counters) against defects in materials and products for a period of 1 year from the date of invoicing of the defective product or component to the distributor. For cooling counters and backbar cooling counters Novameta provides a Manufacturer’s warranty for a period of 3 years.

## **Warranty Exclusions and Limitations of Liability**

The warranty in these Terms shall be the distributor’s exclusive remedy for defective products and components towards Novameta. Novameta shall not be liable for any costs, expenses, losses or claims (whether direct, indirect, consequential or otherwise) relating to defective products or components unless otherwise explicitly stated herein or agreed in writing. Any expenses in connection with the installation or costs of making adjustments (including service procedures, travel time costs) on the equipment to comply with the supply at the point of installation are not covered by this warranty. Novameta does not take any responsibility for damages that occur due to ignorance of cautions, improper maintenance or mechanical damages of the unit, including those, caused during the delivery. The warranty in these Terms is not effective if damage occurs from improper installation, misuse, incorrect voltage supply, wear and tear

from normal usage, accidental breakage, damage or if the equipment is operated contrary to the user instructions. The warranty does not cover if the damage occurs due to natural disasters, fire, if repair was made by unauthorized third party service. In case of a failure not covered by the warranty, we provide a possibility to purchase spare parts.

### **Procedure for Repair or Replacement Under the Warranty**

The distributor shall, at its own costs, make all reasonable attempts to repair any defective component or product. If such repair is not possible for the distributor, the distributor shall contact Novameta in writing. Distributor's contact shall include specific information as to the suspected defect the relevant order number and a copy of the relevant invoice. After receipt of the above, Novameta will decide if there is a defect, whether the claim is covered by the warranty, and whether the product or component is to be replaced. In cases where Novameta decides to replace defective products or components with new ones, general rule is that first of all distributor has to return defective products or components to Novameta for examination and only if it will be acknowledged that these items are covered by warranty, defective products or components will be replaced with new ones. However, if distributor needs new items faster, Novameta offers another option – Novameta will send new product or components immediately, but distributor will be billed the full amount for the goods when they are sent. This amount will then be credited when the defective product or components is returned to Novameta and if it is established that the defective product or component is covered by the warranty. With regard to the transport of products and components, Novameta will pay the freight of new or repaired products and components, while the distributor will pay the freight for defective goods that are returned (and any other costs related to the return of the goods). The warranty does not cover expenses of the service procedures performed. Novameta does not provide service. Unless otherwise agreed in writing, the defective product or component should always be returned to Novameta: Ateities pl. 39 LT-52119 Kaunas Lithuania not later than in 30 days after receipt of the claim.

### **Cancellations**

If an order cancellation request is made after confirmation of drawing and proforma invoice, adjustments are not possible and production cannot be stopped. In case of cancellation product will be charged in full.

### **Shipping and Packing**

Novameta will pack products for shipment in Novameta standard packaging. If the distributor has other requirements as to packing, the distributor shall contact Novameta to make special arrangements.

### **Delivery Recommendations**

Upon receipt, inspect units immediately for any shipping damage. Damage must be reported upon delivery in writing in driver's CMR. Otherwise neither the Manufacturer nor the carrier can take responsibility for transport damage. Party, which has to make a damage claim to carrier, is determined by INCOTERMS 2010 specified in proforma invoice. All items are thoroughly inspected and carefully packed before leaving our factory, thus Novameta cannot accept responsibility for any shipping damage, however Novameta will assist in filing a claim.

### **Control of delivered goods conformity**

Delivered goods must be controlled and inspected at reception to verify that they comply with the order. Any discrepancies regarding the amount, the species or the type of goods, as well as the presence of apparent non-conformities must always be notified in writing, within 5 (five) days of reception, mentioning all the data required to allow immediate control. Once this terms has expired, goods are considered as accepted. Unless otherwise agreed in writing, do not send goods back to Novameta.

### **Liability and Product Liability**

Novameta shall only be liable for defects and product liability to the extent set out herein (see particularly warranty terms). In addition to the aforesaid all liability is capped at the invoiced price of the defective product. All other liability is hereby excluded. In addition, Novameta reserves the right to change product design, technical specifications, combination of materials and prices at any time without prior notice.

### **Force majeure**

Novameta is entitled to cancel orders or suspend delivery and shall not be liable for non-delivery or delayed delivery, which partly or wholly is caused by circumstances beyond Novameta's reasonable control, including, but not limited to strikes, boycotts, lockouts, wars, acts of God or disasters, embargoes, provisions by the Government or other authorities. In this case Novameta, after learning about the impediment, shall inform the distributor within a reasonable term about the circumstances and its likely effects on Novameta's obligations. Distributor is not entitled to any kind of damages in case of cancellation or delayed delivery due to such circumstances.

### **Protection of personal data**

As a part of handling sales and service requests from distributor, Novameta shall process contact and invoice data. Any personal data Novameta may process may be shared with other Novameta group companies. Personal data will not be shared with any third parties other than data processors who process data on behalf of Novameta based on a data processor agreement.

### **Confidentiality**

Distributor does not have right to disclose any confidential information received through doing business with Novameta to the third party without Novameta's permission.

### **Choice of Law and Venue**

These Terms and the cooperation between Novameta and its distributors, including any disputes relating thereto, shall be governed by Lithuanian law. Any disputes shall be settled before the Lithuanian courts, which shall have exclusive jurisdiction.

UAB „Novameta“

Company No. 235886490

VAT Reg. No. LT 358864917

IBAN: LT227300010071982293, Swedbank, AB

Ateities pl. 39, LT-52119 Kaunas, Lithuania

novameta@novameta.lt

www.novameta.lt